

KB6340,1,2,3,6,7,8AL

Single Handle Pressure Balanced Tub & Shower Faucet

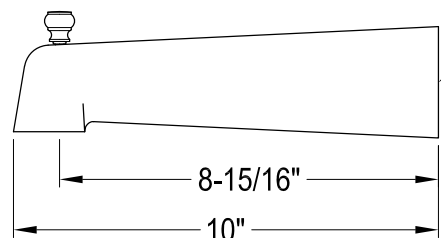
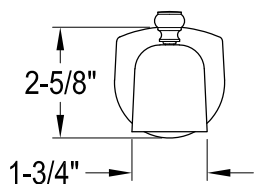
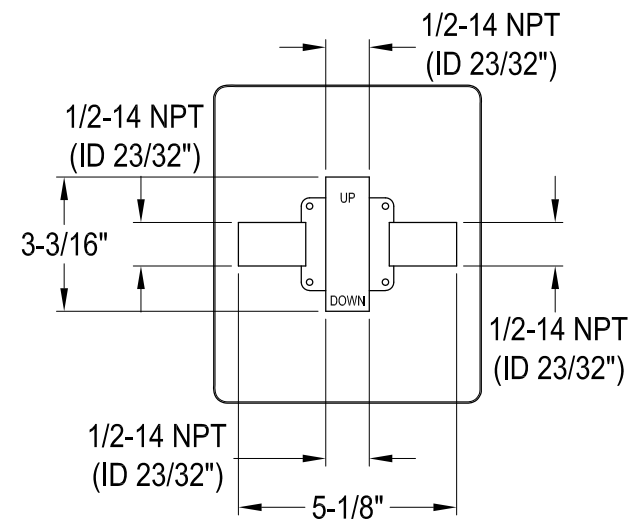
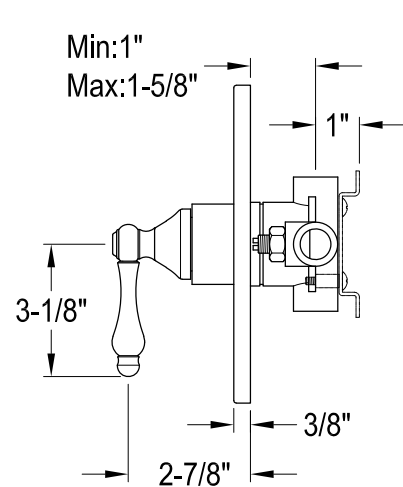
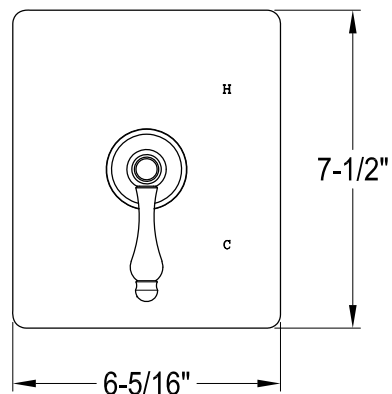
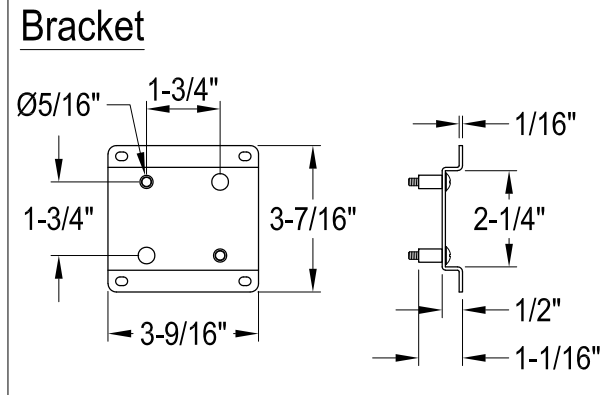
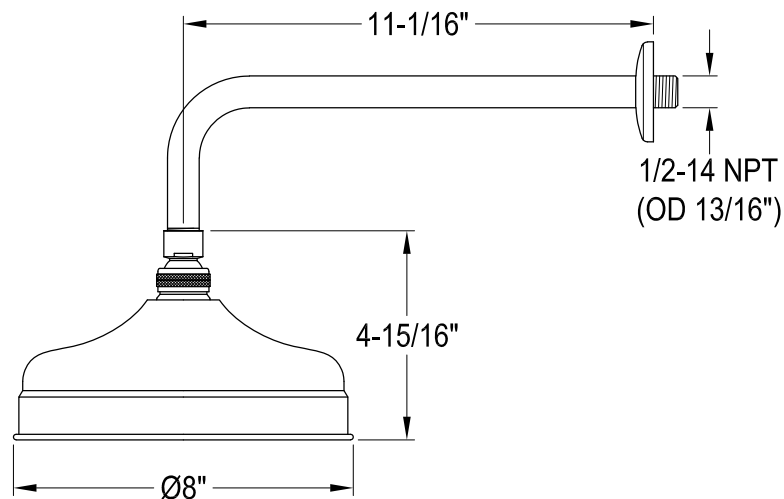
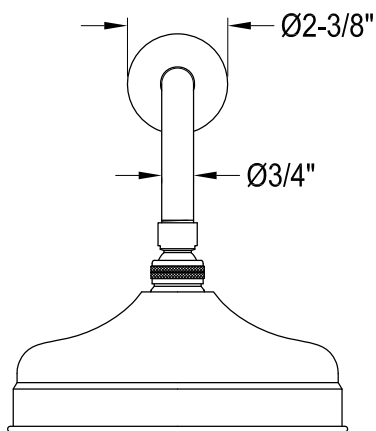

Fit $1/2"$ Copper Pipe (OD $5/8"$)
or $1/2\text{-}14$ NPT (ID $23/32"$)
or $3/4\text{-}14$ NPT (ID $15/16"$)