

# EV2019W38

## Semi-Recessed Bathroom Sink

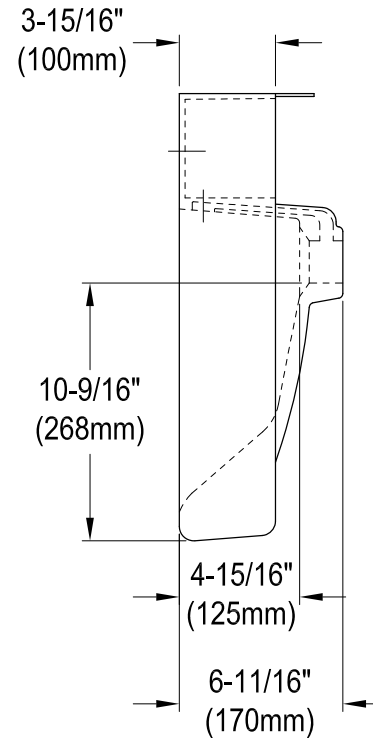
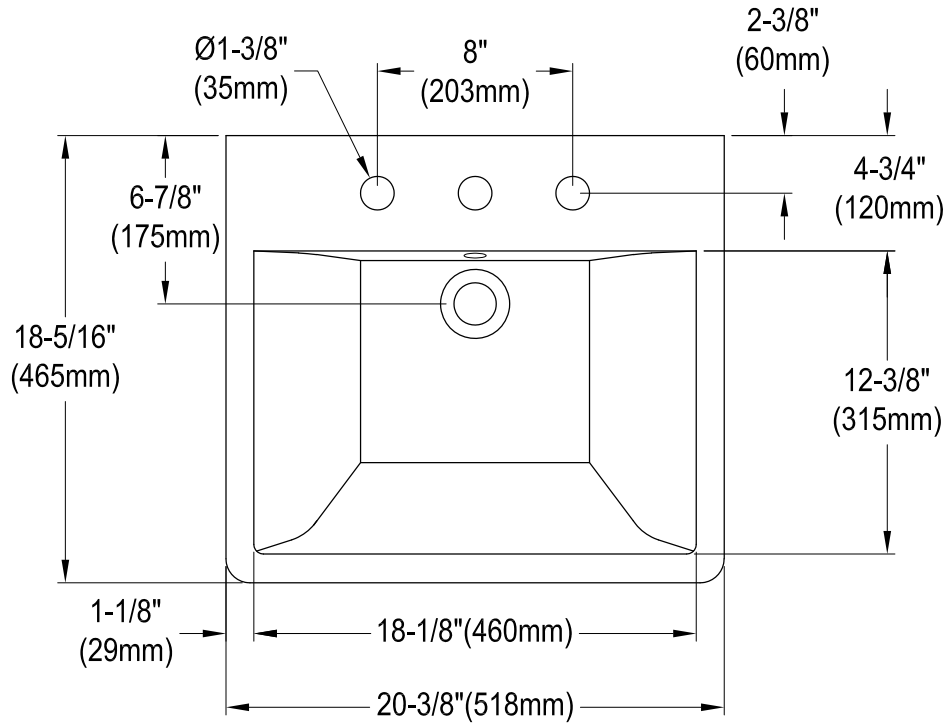

### Drain Hole Size

Scale (3:1)

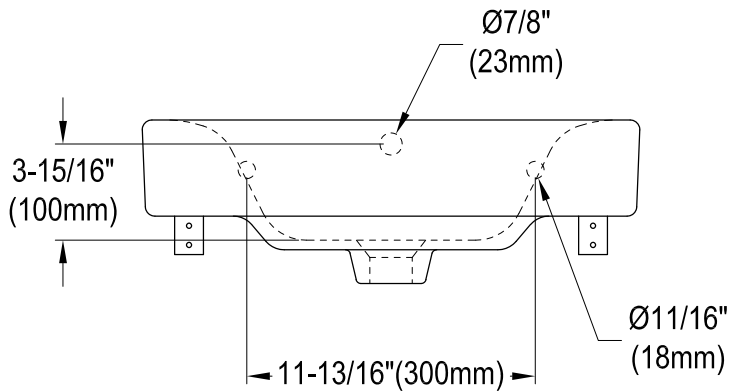
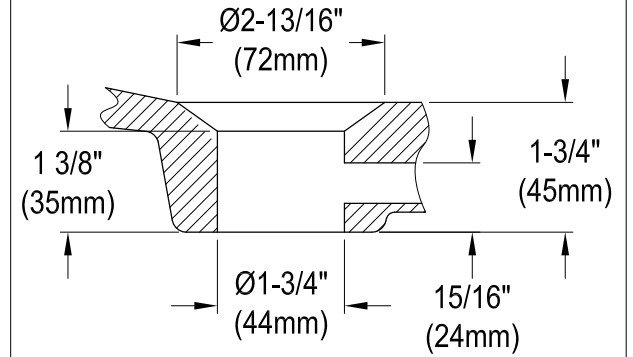

### Bracket (2 pcs)

Scale 2:1

