

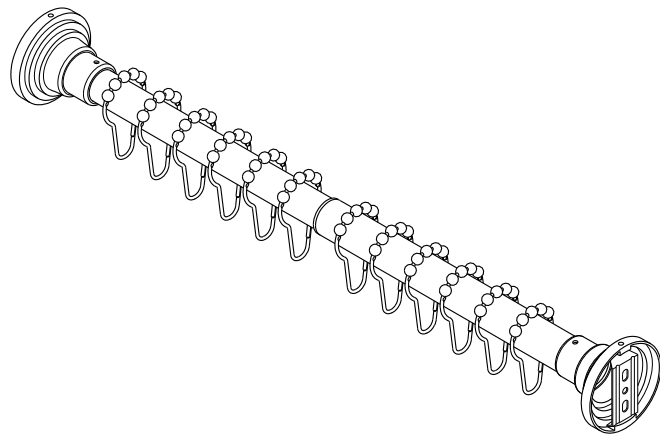

Adjustable Shower Rod with Curtain Ring Combo Installation

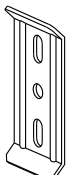
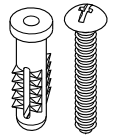
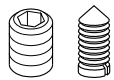
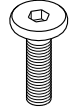

Parts:

Mounting Plate	Mounting Screw & Anchor	Slotted Set Screw	Set Screw	Curtain Ring
				
2 Pcs	4 Pcs	2 Pcs	2 Pcs	12 Pcs

www.kingstonbrass.com
 TOLL-FREE CUSTOMER SERVICE: 1-877-2-KBRASS
 TECHNICAL SUPPORT E-mail: service@kingstonbrass.com
 12775 Reservoir Street, Chino, CA91710

TOOLS REQUIRED

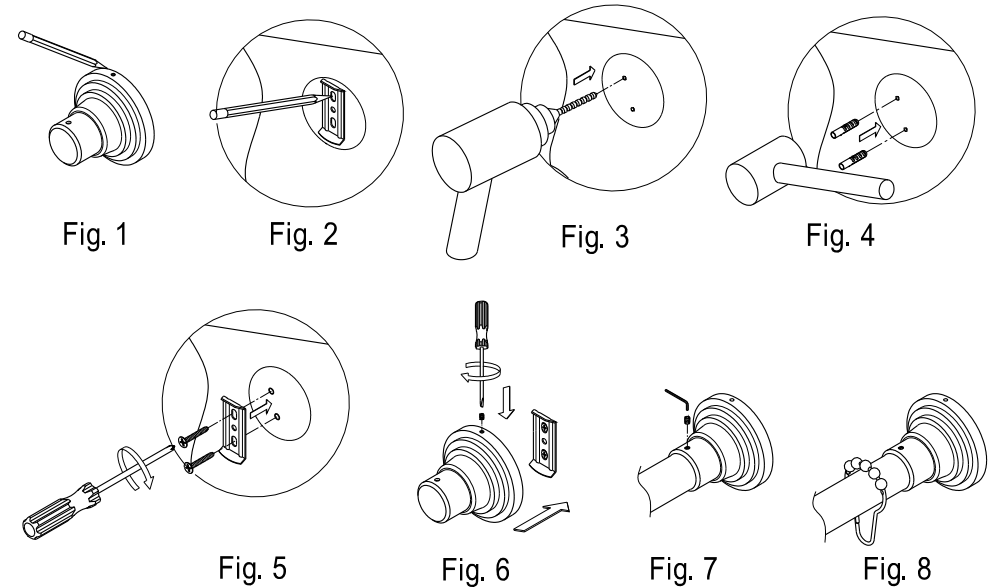
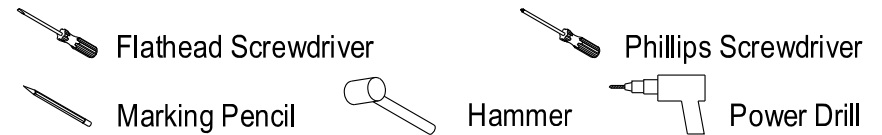

Installation Steps:

- Step 1. Locate where you would like to install the base.
Place a base onto the wall and trace around it with a pencil (fig 1).
- Step 2. Unscrew the slotted set screw of the base and remove the mounting plate.
- Step 3. Place the mounting plate in the center of the pencil outline you just made and mark the location of the mounting screws (fig 2). Drill holes at the marked locations (fig 3).
- Step 4. Insert anchors into the holes with a hammer until flush with the wall (fig 4).
- Step 5. Screw the mounting plate (with the lips facing out) to the wall with the mounting screws (fig 5).
- Step 6. Place the mounting unit against the mounting plate that is installed to the wall surface. Above the mounting unit there is a small screw hole, tighten the set screw with a flathead screwdriver until it is securely fixed to the wall (Fig 6).
- Step 7. Attached shower rod into the mounting unit and screw the shower rod in securely (Fig 7).
- Step 8. Slide shower rings onto shower rod by putting the rod through the opening of the rings (Fig 8).

Cleaning

Clean with a damp cloth only.
 Avoid using metal or abrasive polishes.