

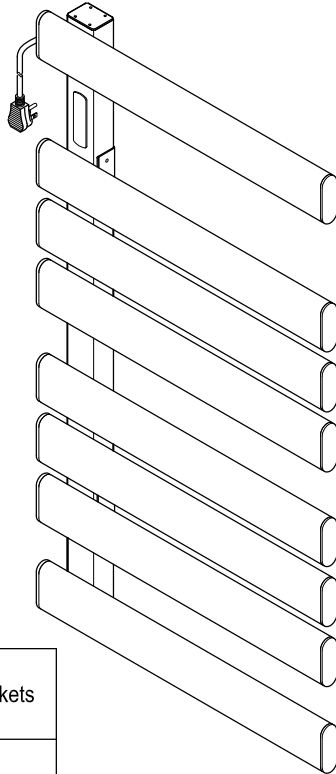

# KINGSTON

KITCHEN & BATH

## Wall Mount Electric Towel Warmer Installation

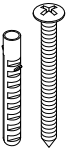

### Parts:

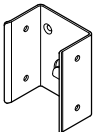
Mounting Screw & Anchor	Screw	"U" brackets
		
4 Pcs	4 Pcs	2 Pcs

www.kingstonbrass.com  
TOLL-FREE CUSTOMER SERVICE: 1-877-2-KBRASS  
TECHNICAL SUPPORT E-mail: service@kingstonbrass.com  
12775 Reservoir Street, Chino, CA 91710

### CAUTION

Failure to follow all installation directions may cause product to detach from the wall and cause serious injury

## 1. Caution

1. To avoid any possible risk or danger, any change of or repair to the damaged internal wires must be done by a qualified technician who is deemed qualified by the industry standard.
2. When moving the product, ensure the main part of the product is properly held and moved, and not dragged by the cable to prevent damage.
3. Any hard scrubbing or scratching to the product surface is strictly prohibited, as is the use of any cleaning products which contain acid or corrosive agents.
4. Household Use Only.
5. Do not immerse in water.
6. Hot Surface. Avoid Contact.
7. Do not put the intelligent towel rack, the power cord and the power head into the water to ensure the electrical circuit dry.
8. Only use for drying textiles which have been dampened by water.
9. The original wire cannot be replaced, when it is unworkable, the whole product should be replaced.
10. If the appliance is supplied from a cord extension set or electric portable outlet device, and the cord extension set or electric portable outlet device should be positioned so that it is not subject to splashing or excessive moisture.
11. The towel rail of this product MUST be installed at least 600mm above the floor in order to avoid risk of harm to young children.

### DANGER



The surfaces on this towel warmer will be hot; do not allow unsupervised children or elderly persons near this device as it can cause severe burns.

### DANGER

Hazardous voltage (120v).  
Contact may cause electrical shock and injury.  
Disconnect power before servicing  
This equipment is to be serviced by trained personnel only

## 2. Product Introduction

1. The Electric towel rack is designed for drying and heating for towels and other bath items, moisture-proof, sterilization, odor elimination and so on the product is environmentally friendly, highly efficient and energy-saving, with simple installation, safe and convenient use, fast heating speed, slow thermal resistance attenuation, long life using time.
2. It is heated by automatic control stabilized temperature is at 90°F~140°F , the clothes will not be damage by high temperature. It is Low power, safe and reliable, economical and power saving. It is widely used in household bathroom, kitchen, washroom, hotel and so on.

### Product Parameters

Product Name	Electric Towel Warmer
Model No	DTC203540
Power	90W-110W
Voltage	110V-120V AC/60Hz
Temperature	90°F~140°F
Heating Mode	Alloy
Shell heat conduction medium	Aluminum alloy

## 3. How to Use

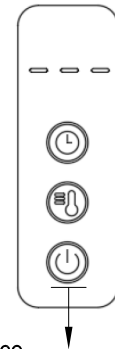
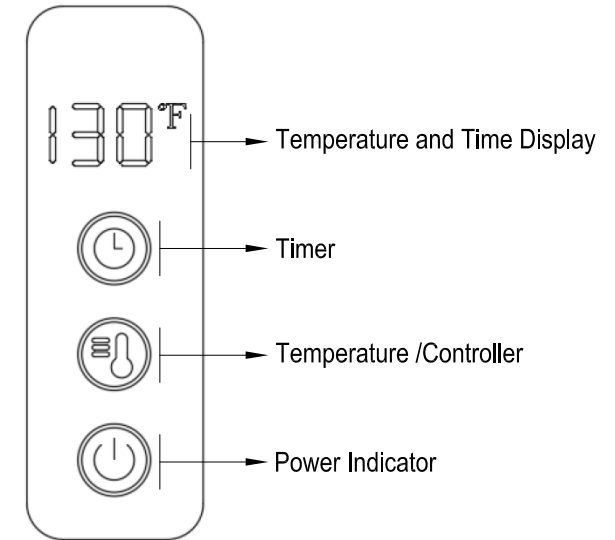

1. Start device:  
Long press the "indicator button" for 3 seconds to turn on the device.

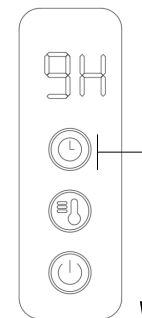

2. Set time length:  
Short press "set time" button, add 1 hour for each time, cycle from 1 hour to 9 hours.

## 4. Installation Aids and Using Environment

### 3. Setting temperature:

Short press the "set temperature" button to increase 10°F every time and cycle from 90°F to 140°F.

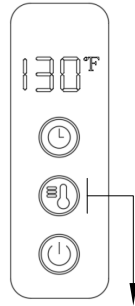

### 4. Manually shut down the equipment:

Long press the "indicator button" for 3 seconds.

This product has temperature protection function, that is limit the maximum temperature not to exceed the set temperature to ensure safe use.



1. The product should be installed or used in a dry and cool indoor environment. Do not expose the product to a hot or wet environment.
2. This product is only for indoor use. Outdoor use is prohibited. Installation and use of the location should be as far as possible away from the shower room, bath or accommodate, where is easily splashed by water.
3. There should be a separate three-hole socket with rated voltage 120V/60Hz within 1.2m from the installation position, and reliable ground wire connection.
4. The structure of the installation position must be strong to avoid falling off or causing accidents.
5. The product should be installed or used far away from children. Children under 12 years old are not allowed to hang the product or play or use it alone.

### Tools Required

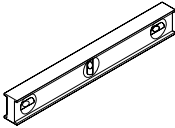
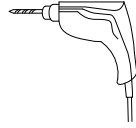
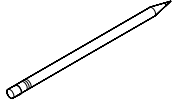
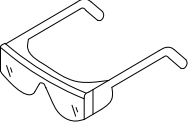
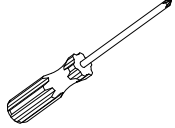
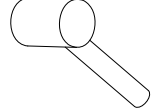
Spirit Level		Impact Drill	
Marking Pencil		Goggle	
Screwdriver		Hammer	

## 5. Installation Method

1. Determine the desired location of your towel rack and mark a leveled vertical 17" line.
2. Place the enclosed template so that the edge is even with the marked line on the wall, secure to the wall by using painters tape at both ends.
3. If the towel rack is going to be installed on wood, drill 1/16" pilot holes, remove template and attach the "U" brackets using the enclosed screws, make sure that the protruding hooks are pointing up.
4. If the towel rack will be installed on drywall, drill 1/4" holes at the marked locations on the template, remove template, insert plastic anchor and tap lightly with a hammer, attach the "U" brackets using the enclosed screws, make sure that the internal protruding hooks are pointing up.
5. Attach the towel rack to the wall by inserting the vertical post on the "U" brackets, slide down until the post has engaged the internal hooks on the "U" brackets, secure by threading screws on the side of the "U" brackets.
6. Power Cord and Plug Connection.

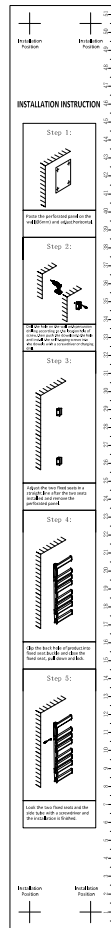
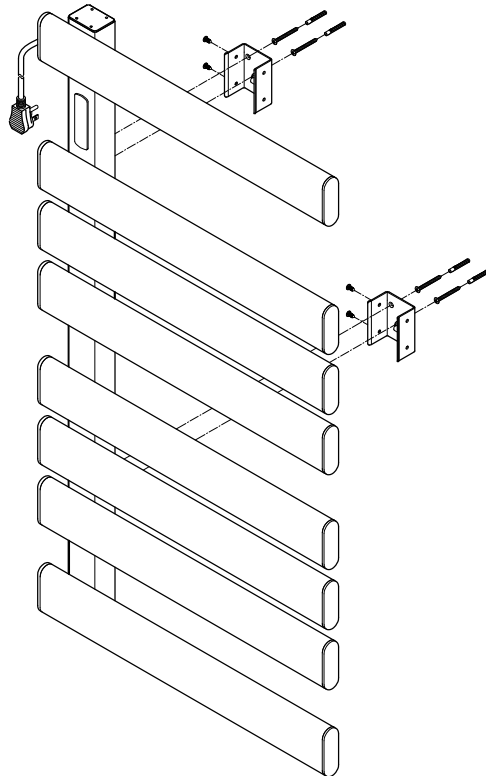

## 6. Cleaning and Maintaining

1. In order to keep the heating towel rack clean, please clean it regularly.
2. Before cleaning the electric heating towel rack, be sure to unplug the power head to make the electric heating towel cold.
3. Do not put the intelligent towel rack, the power cord and the power head into the water to ensure the electrical circuit dry.
4. Do not use detergent, nylon, abrasive cloth or sandpaper containing phase particles such as cleaning powder or polishing powder to avoid damaging the product.
5. Only use soft cotton cloth to wipe the intelligent towel rack.
6. If you need to do a lot of cleaning work, please follow the following procedures:
  - A. Use a slightly wet soft cloth to remove the surface dirt as much as possible.
  - B. Use any of the following cleaners to remove the surface dirt and fouling film mild liquid cleaner; a light liquid cleaner that does not have damaging effect colorless glass cleaner, powder cleaning agent that can be completely dissolved in the well without research effect ( the well is combined according to the instructions). Stubborn dirt can be hot bubble, then ship or toothpaste or special hard ware cleaner. to remove stubborn water stains, you can use a fresh lemon slice and rub it around the water stains for several times to remove them or the thick skin with enough water can also play a strong role in removing water. The color side of the belt does not need to be vigorously well, the dirt on towels can be easily removed.
  - C. After cleaning, please use a soft cloth with low temperature to clean all cleaning agents, and use a soft cotton cloth to wipe it dry. only continuously to use it after completely dry.