

KINGSTON

KITCHEN & BATH

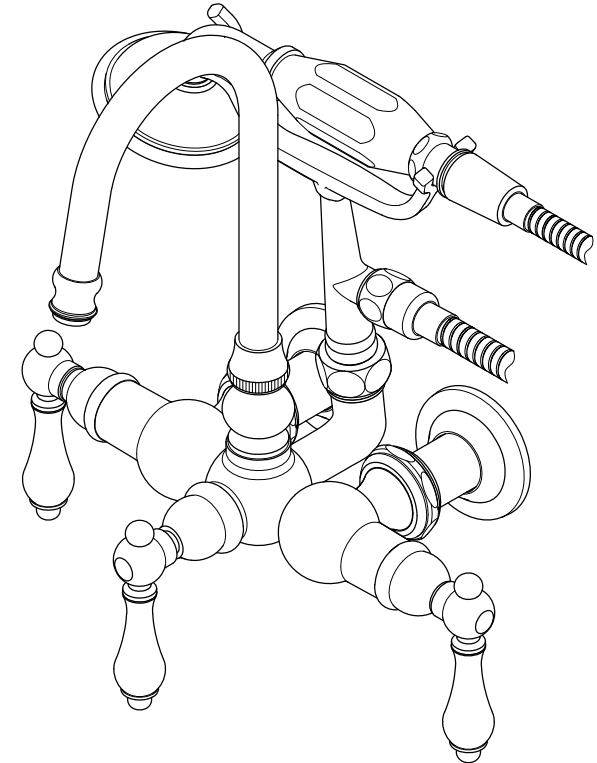

Parts:

Lock Nut

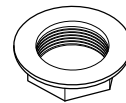

2 Pcs

www.kingstonbrass.com
TOLL-FREE CUSTOMER SERVICE: 1-877-2-KBRASS
TECHNICAL SUPPORT E-mail: service@kingstonbrass.com
12775 Reservoir Street, Chino, CA 91710

NOTICE

Failure to follow all directions may cause leaks
which may result in water damage

CAUTION

Failure to follow all installation directions may
cause product to detach from the wall and
cause serious injury

KINGSTON

KITCHEN & BATH

INSTALLATION INSTRUCTIONS Wall Mount Tub Filler with Hand Shower

BEFORE BEGINNING INSTALLATION:

1. Flush plumbing lines to clear any debris.
2. Shut off both supply lines after flushing.

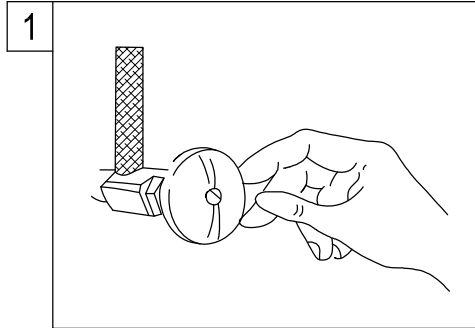

1. Shut off main water supply valve before installation.

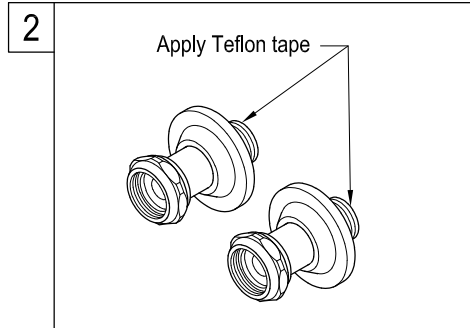

2. Apply Teflon tape on the threads of the copper shanks. Install the elbow.

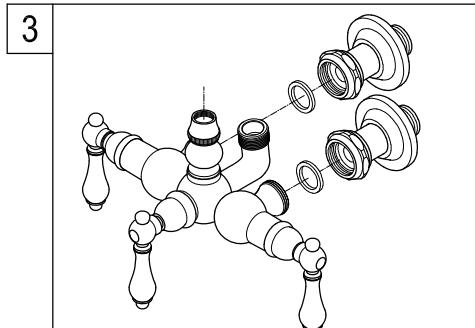

3. Before mounting the faucet onto supply elbows, apply small black washers onto both water inlets of faucet.

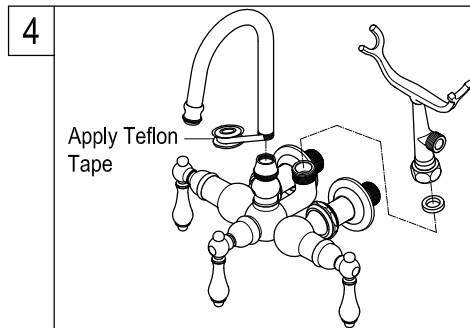

4. Apply Teflon tape onto threads of spout. Install the shower cradle and spout on top of faucet body.

Need Tools:



Basin Wrench



Adjustable Wrench



Teflon Tape



Silicone Sealant



Screwdriver

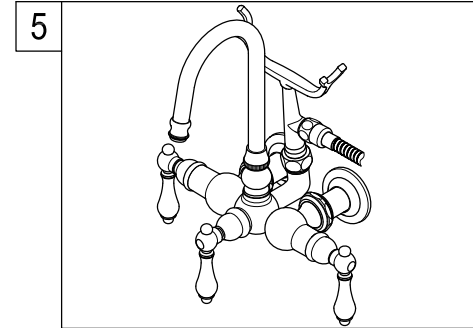

5. Place a washer between the side hole of the shower cradle and the cone nut of the shower hose. Tighten the cone nut.

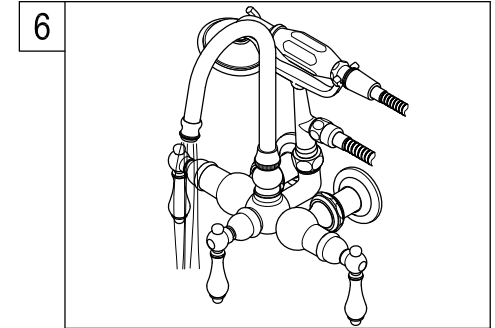

6. Turn on the faucet and let hot and cold water to run for at least one minutes to clean any debris inside the water line.

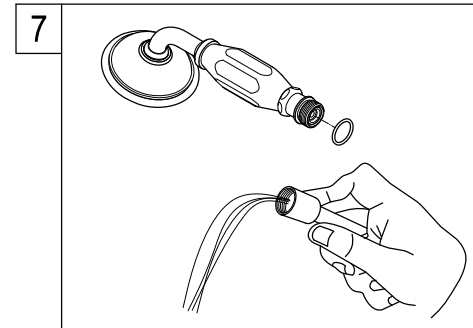

7. Remove shower by unscrewing the shower in a counter clockwise direction, turn on both hot and cold valves and let water run for at least one minute, this will clear any debris left in the line.

Warning!!!

- **DO NOT STEP ON faucet or supply line installation.** This fixture is not a stair to access your storage, window or access higher ceiling. This Cast Brass Faucet cannot support your body weight. To step on faucet will crack the fitting and eventual fracture to cause water damage to your property.
- The faucet was tested and meets ASME/ANSI code on its operation, loading and torque pressure. However this faucet is not designed to support weight over 250 pound per square inch of pressure, **DO NOT OVERTIGHTEN.** **DO NOT APPLY ELECTRICAL TOOL** to fasten faucet installation.
- For Exposed tub supply line installation faucet model, your supply lines have to be installed on corner area, or at area with no walking traffic access to cause accidental tamper or accidental breakage. For installation of exposed supply line at open traffic area is prohibited.
- Removal of this tag prior to installation will void your warranty. Pass the WARNING TAG to the owner after installation.

KINGSTON

KITCHEN & BATH

Single Offset Bath Supply Installation

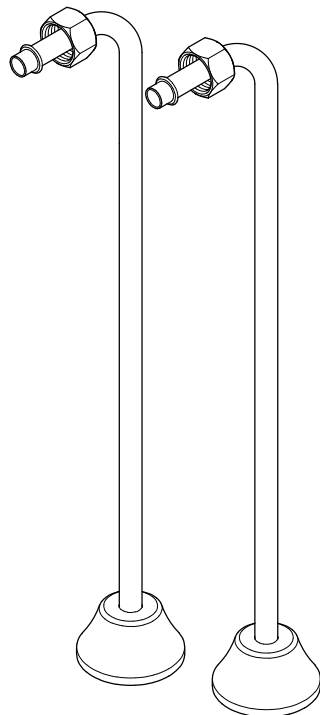

Parts:

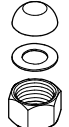
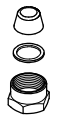
Escutcheon	Cone Washer & Coupling Nut & Friction Ring (3/4-14 NPS)	Cone Washer & Coupling Nut & Friction Ring (1/2-14 NPS)
		
2 Pcs	2 Pcs	4 Pcs

NOTICE

Failure to follow all directions may cause leaks which may result in water damage

www.kingstonbrass.com
 TOLL-FREE CUSTOMER SERVICE: 1-877-2-KBRASS
 TECHNICAL SUPPORT E-mail: service@kingstonbrass.com
 12775 Reservoir Street, Chino, CA 91710

Before starting the installation :

Straight supply lines are designed to be installed on tubs that are configured for deck mount faucets, and should be installed at the same center to center distance as that of the tub faucet holes, the supply lines should be installed in a plumb vertical position ,before starting the installation we recommend:

- That you have the supply lines and faucet at the jobsite prior to preparing the rough-in water supply.
- Decide if you are going to add shut-off stops to your supply lines, and if so, have them on-site.

Installation Steps:

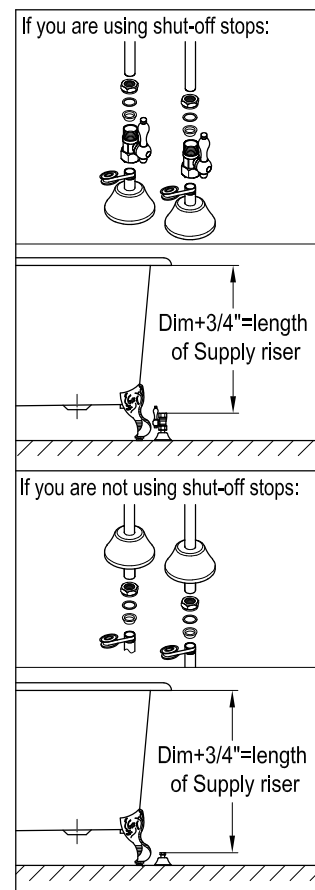

1. Place the tub at the desired location and install the faucet on the tub, using the supply lines mark the location where the supply pipe rough-in should be located, taking into account that the supply line will be recessed into the faucet shank up to the built-in ridge stop, make sure that the center to center dimension on the rough-in pipe is the same as the center to center distance of the faucet holes on the tub, the supply lines are designed to be installed in a vertical plumb position, make sure the rough-in water supply pipes are well secured to impede any movement that would pull on the connection to the supply lines.
2. Rough in the supply pipe to accommodate either the shut-off stops or the supply line.
3. If you are using shut-off stops, make sure that the outlets on the shut-off stops are designed for a 1/2" compression outlet, you will also need to add a flange that will accommodate the diameter of the pipe that you are using as a supply rough-in, install flange and shut-off stop, measure the distance between the top of the shut-off valve and the center of the faucet holes on the tub and add 3/4", cut supply line to the appropriate dimension.
4. If you are not using shut-off stops, measure from the center of the faucet inlet shanks to the fitting on your supply line rough-in and add 3/4", this will determine the height of your supply line allowing enough space so that the supply line is inserted sufficiently into your fitting and does not pull on the supply line as this may cause leaking, cut supply line at the appropriate dimension.
5. Slide the friction washer and cone washer on the horizontal section of the supply line, from the bottom slide the nut all to the top, slide in bell flange, 1/2" nut, friction washer and cone washer, apply Teflon tape and thread into your rough-in pipe or shut-off valve.
6. Apply Teflon tape on the faucet shanks and thread the coupling nuts, open the shut-off valves and check for leaks.

Warning!!!

- Make sure that supply lines are installed in a vertical plumb position, failure to do so may pull on the supply lines and cause leaking.
- Reshaping, bending or altering supply line (except for cutting to size) or use of nuts or washers not supplied with this kit will void your warranty.
- It is recommended that the tub be situated in an area where the supply lines are not exposed to foot traffic, bumping into the supply lines may damage them and potentially cause a leak.

Installer:

Please pass this label on to homeowner after installation.

KINGSTON

KITCHEN & BATH

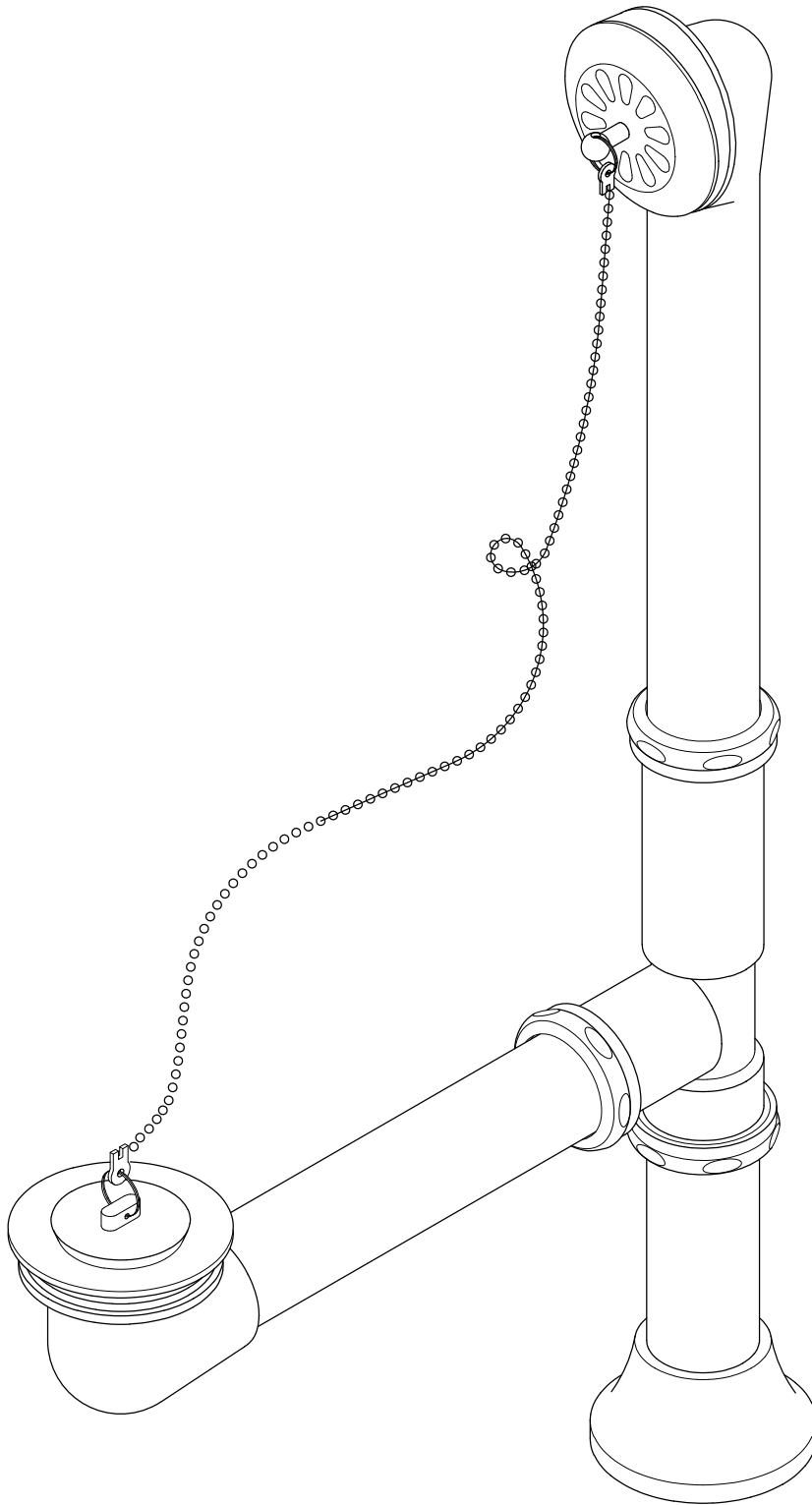

NOTICE

Failure to follow all directions may cause leaks
which may result in water damage

www.kingstonbrass.com

TOLL-FREE CUSTOMER SERVICE: 1-877-2-KBRASS

TECHNICAL SUPPORT E-mail: service@kingstonbrass.com

12775 Reservoir Street, Chino, CA 91710

KINGSTON

KITCHEN & BATH

INSTALLATION INSTRUCTIONS

Brass Tub Bath Drain

- Note:
1. Observe all local plumbing and building codes.
 2. Inspect waste and supply tubing; replace if necessary.
 3. If you are installing a new bath, install the drain before installing the bath.
Refer to the manufacturer's installation instructions.
 4. The brass tube on (4) or (9) is glued on its elbow and can be trimmed to fit the tub.
Don't try to disassemble the brass tube from elbow, or it will cause water leakage.

TOOLS REQUIRED

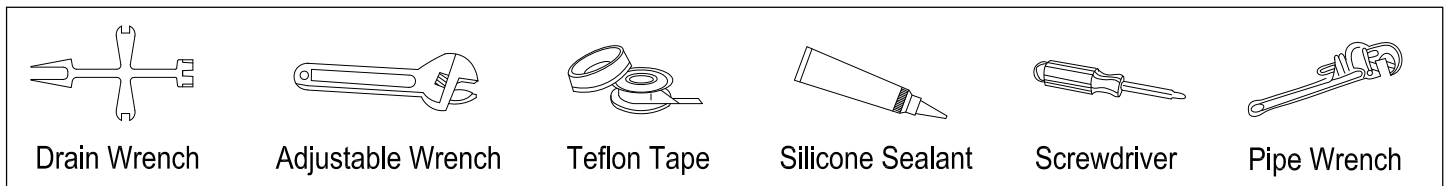

INSTALLATION INSTRUCTIONS:

1. Place rubber washer (10) onto waste tube (9) and set them under the tub.
2. Apply Teflon tape on strainer thread and a bead of silicone sealant under waste strainer (11) and thread into waste tube (9). Wipe off excess sealant.
3. Because the back slope angle on tubs vary, we have included 2 gaskets for you, select the rubber gasket that more closely matches your tubs angle, discard remaining rubber gasket. Place rubber gasket (3 or 3-1) on elbow portion of the overflow tube, hold to the back of the tub at the overflow opening and screw in cover plate.
4. Slip joint nuts (5) and Washers (6) onto overflow tube (4), waste tube (9) and drain tube (8).
5. Apply Teflon tape to all three threads on three way tee (7).
6. Slip tee onto the waste tube (9), overflow tube (4) and drain tube (8), adjust to desired location and tighten slip joint nuts.
Depending on the size of your tub it may be necessary to cut any or both tubes.
7. Thread on drain tube (8) and onto the escutcheon (12), make the necessary connection to your drain system.
8. Fill tub with water, sufficient to cover the overflow cover plate (2), check for leaks and retighten any connections as necessary.

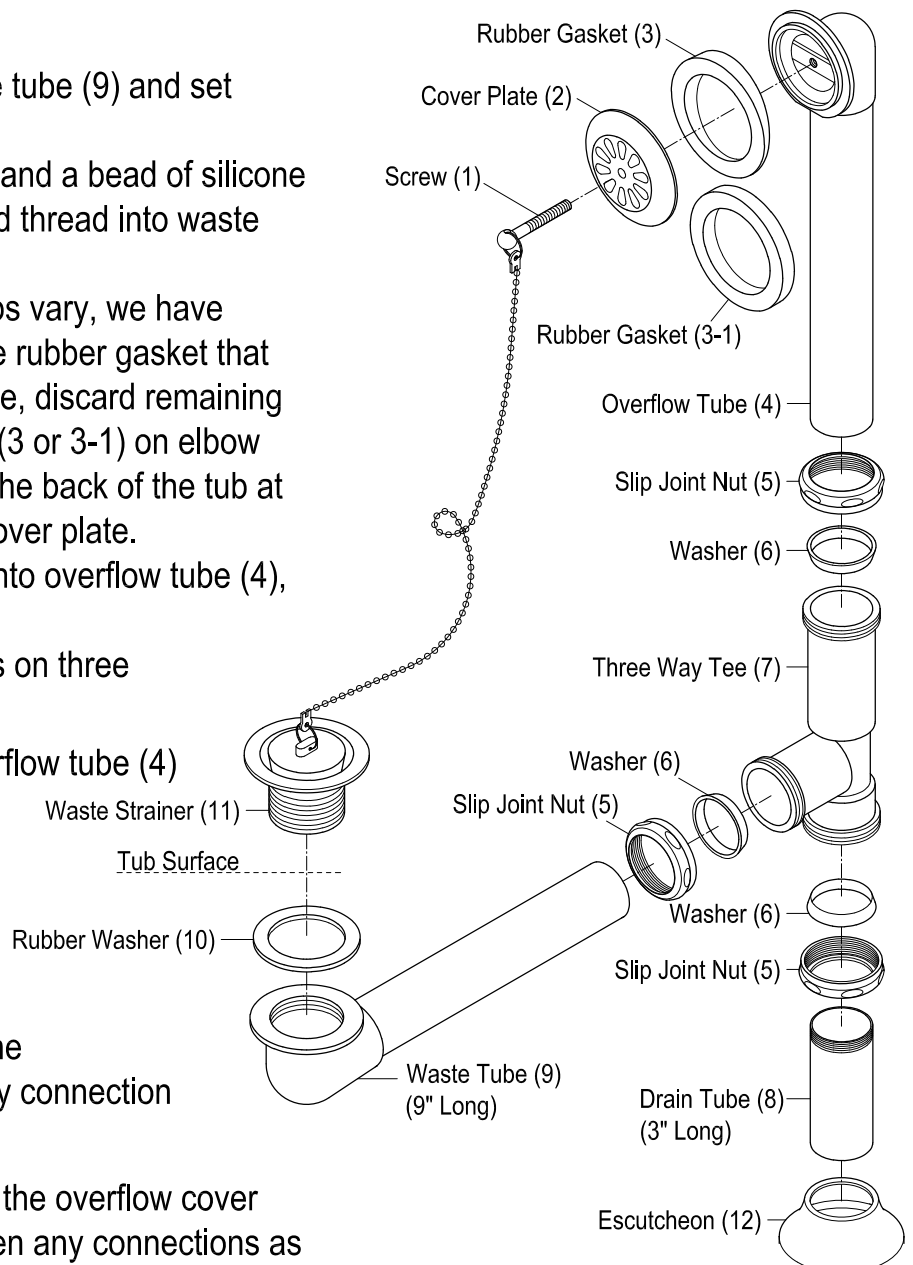

KINGSTON

KITCHEN & BATH

FITTING PROCEDURE

Soap & Sponge Holder

Because there are many different sizes and shapes of tub rims the Soap & sponge holder is designed to be adjusted to your specific tub rim.

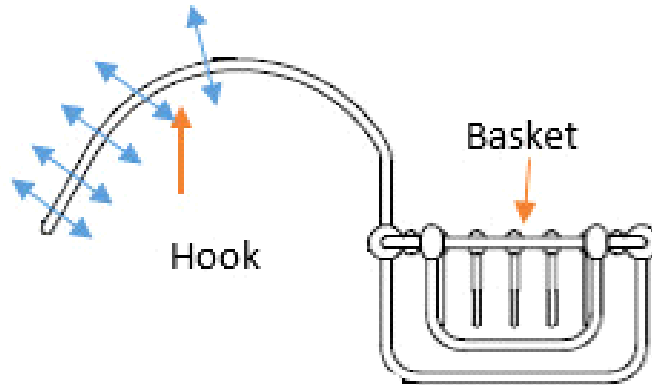

While holding the basket with one hand, grab the hanger hook and bend it slightly, place it on the tub, if the basket is still sagging, re-adjust the hook as necessary.

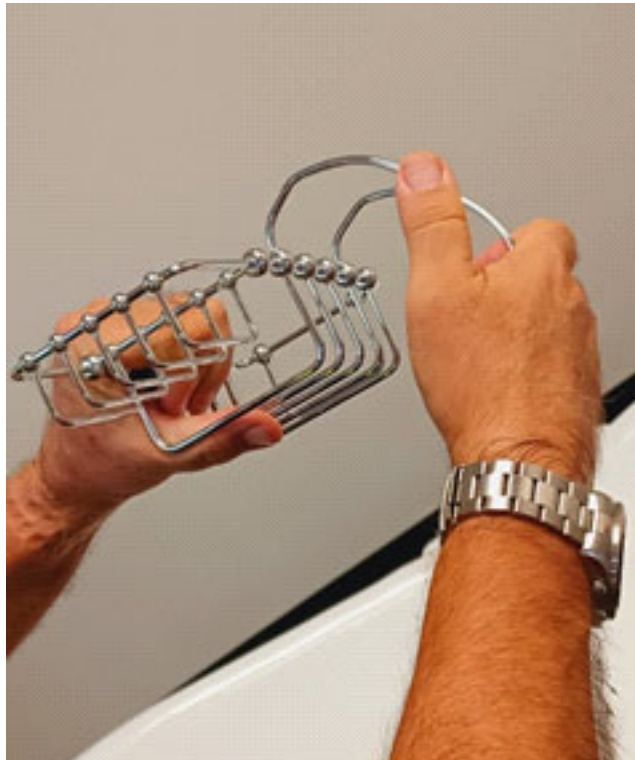

www.kingstonbrass.com

TOLL-FREE CUSTOMER SERVICE: 1-877-2-KBRASS

TECHNICAL SUPPORT E-mail: service@kingstonbrass.com

12775 Reservoir Street, Chino, CA 91710

KINGSTON

KITCHEN & BATH

INSTALLATION INSTRUCTIONS

Straight Stop

Instructions:

1. Apply thread sealant tape to threads (1).
2. Screw valve body (2) onto pipe (3).
3. Place nut (4), metal washer (5) and rubber washer (6) on tube (7).
4. Insert tube (7) into valve.
5. Wrench tighten nut (4) onto valve.
6. Stop any leaks by tightening nuts slightly.

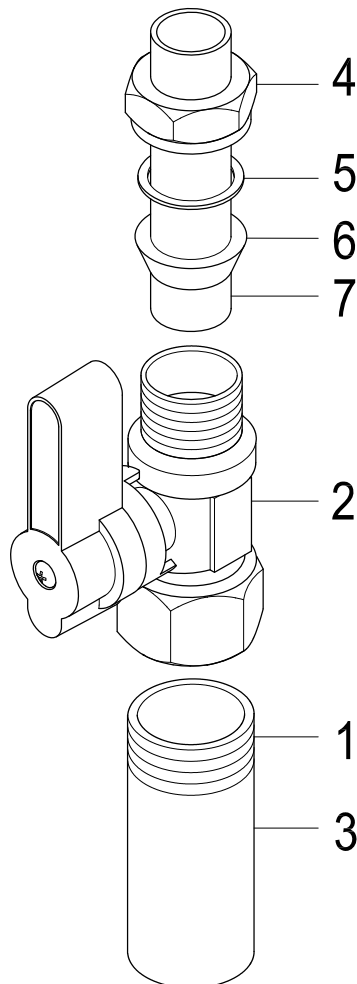

NOTICE

Failure to follow all directions may cause leaks
which may result in water damage

www.kingstonbrass.com
TOLL-FREE CUSTOMER SERVICE: 1-877-2-KBRASS
TECHNICAL SUPPORT E-mail: service@kingstonbrass.com
12775 Reservoir Street, Chino, CA 91710