

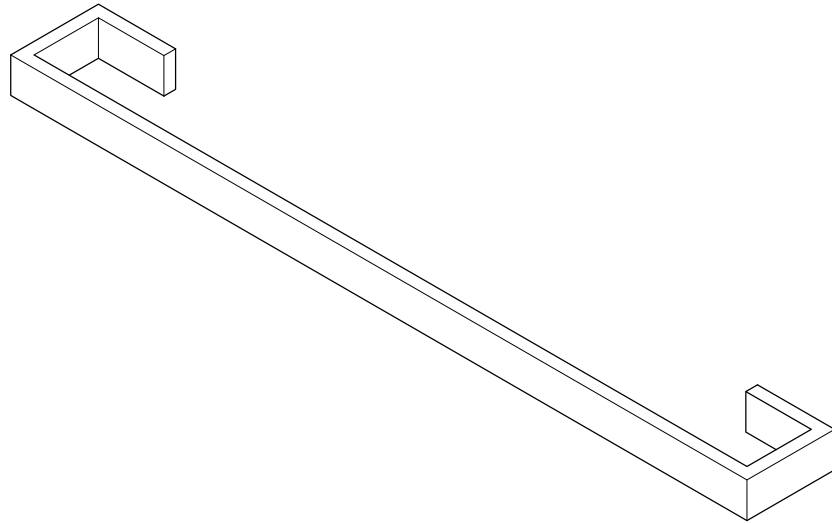

KINGSTON

KITCHEN & BATH

Towel Bar Installation

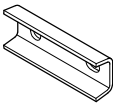
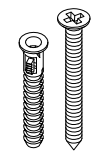

Parts:

Mounting Bracket	Mounting Screw & Anchor	Set Screw
		
2 Pcs	4 Pcs	4 Pcs

CAUTION

Failure to follow all installation directions may cause product to detach from the wall and cause serious injury

www.kingstonbrass.com
 TOLL-FREE CUSTOMER SERVICE: 1-877-2-KBRASS
 TECHNICAL SUPPORT E-mail: service@kingstonbrass.com
 12775 Reservoir Street, Chino, CA 91710

TOOLS REQUIRED

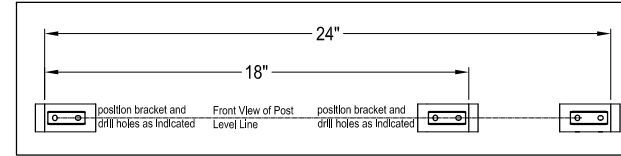
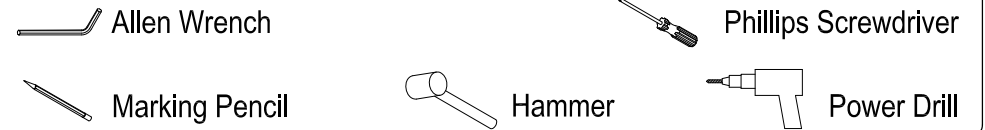

Fig. 1

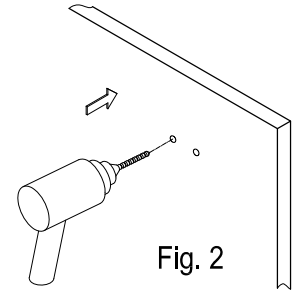

Fig. 2

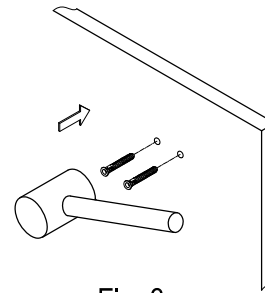

Fig. 3

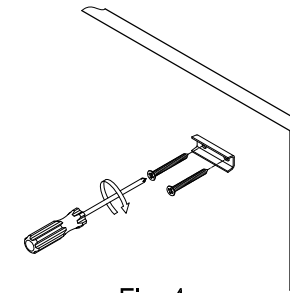

Fig. 4

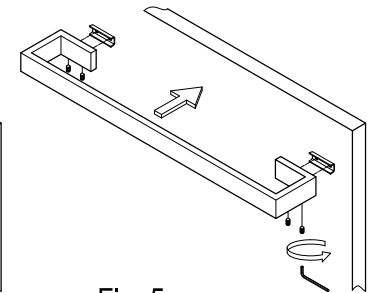

Fig. 5

Installation Steps:

- Step 1. Locate where you would like to install the towel bar by measuring from end to end on the towel bar then measure the desired height on the wall where the towel bar will hang (fig 1).
- Step 2. Position the mounting template on the desire location, and use a level to make sure it is level.
- Step 3. Use a pencil to mark both bracket holes. Repeat this step for the other side.
- Step 4. Remove the template from wall and use a 1/4" drill bit to pre-drill holes in the drywall where pencil marks are drawn (fig 2).
- Step 5. Hammer in the drywall anchors until flush with the wall (fig 3).
- Step 6. Secure the mounting brackets (with the rib facing down) to the wall using the provided screws (fig 4).
- Step 7. Insert the unit with holes facing down to the bracket and tighten setscrews with an Allen wrench until the base is tight and secure (fig 5).

Cleaning

Clean with a damp cloth only.
 Avoid using metal or abrasive polishes.