

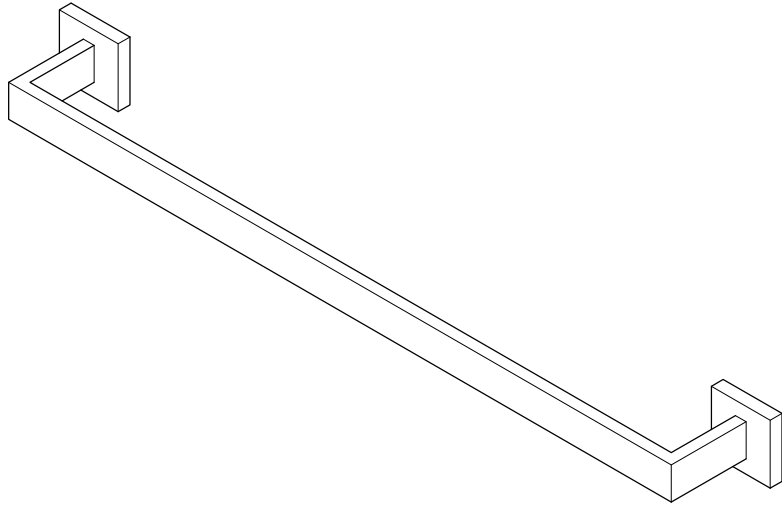

# KINGSTON

KITCHEN & BATH

## Towel Bar Installation

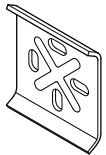
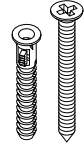

### Parts:

Mounting Bracket	Mounting Screw & Anchor	Set Screw
		
2 Pcs	4 Pcs	2 Pcs

## CAUTION

Failure to follow all installation directions may cause product to detach from the wall and cause serious injury

www.kingstonbrass.com  
 TOLL-FREE CUSTOMER SERVICE: 1-877-2-KBRASS  
 TECHNICAL SUPPORT E-mail: service@kingstonbrass.com  
 12775 Reservoir Street, Chino, CA 91710

### TOOLS REQUIRED

 Allen Wrench

 Phillips Screwdriver

 Marking Pencil

 Hammer

 Power Drill

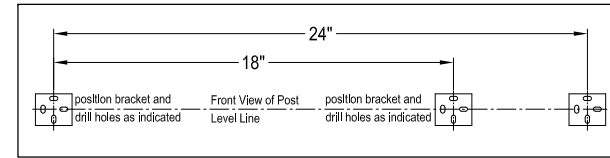

Fig. 1

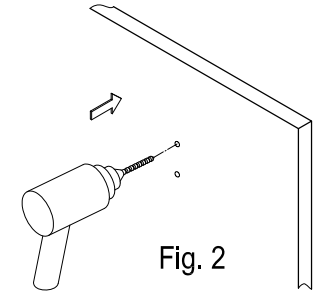

Fig. 2

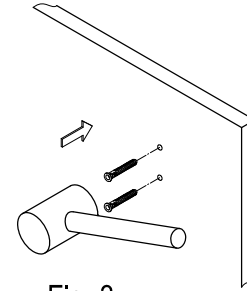

Fig. 3

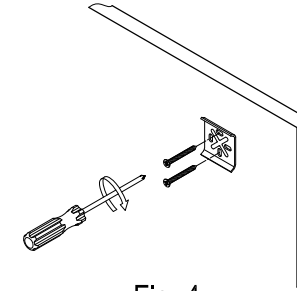

Fig. 4

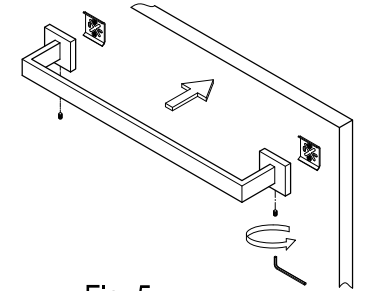

Fig. 5

### Installation Steps:

- Step 1. Locate where you would like to install the towel bar by measuring from end to end on the towel bar then measure the desired height on the wall where the towel bar will hang (fig 1).
- Step 2. Position the mounting template on the desire location, and use a level to make sure it is level.
- Step 3. Use a pencil to mark both bracket holes. Repeat this step for the other side.
- Step 4. Remove the template from wall and use a 1/4" drill bit to pre-drill holes in the drywall where pencil marks are drawn (fig 2).
- Step 5. Hammer in the drywall anchors until flush with the wall (fig 3).
- Step 6. Secure the mounting brackets (with the holes on a level) to the wall using the provided screws (fig 4).
- Step 7. Insert the unit with holes facing down to the bracket and tighten setscrews with an Allen wrench until the base is tight and secure (fig 5).

### Cleaning

Clean with a damp cloth only.  
 Avoid using metal or abrasive polishes.



# KINGSTON

KITCHEN & BATH

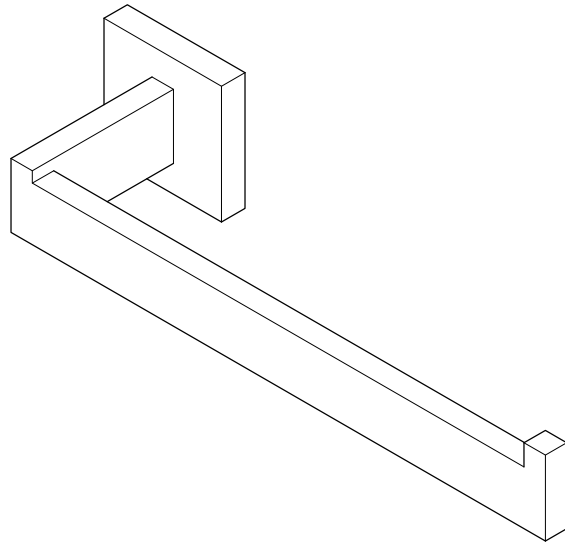
## Towel Holder Installation

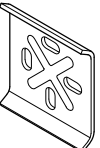
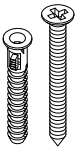

### Parts:

Mounting Bracket	Mounting Screw & Anchor	Set Screw
		
1 Pc	2 Pcs	1 Pc

## CAUTION

Failure to follow all installation directions may cause product to detach from the wall and cause serious injury

www.kingstonbrass.com  
TOLL-FREE CUSTOMER SERVICE: 1-877-2-KBRASS  
TECHNICAL SUPPORT E-mail: service@kingstonbrass.com  
12775 Reservoir Street, Chino, CA 91710

### TOOLS REQUIRED

 Allen Wrench

 Phillips Screwdriver

 Marking Pencil

 Hammer

 Power Drill

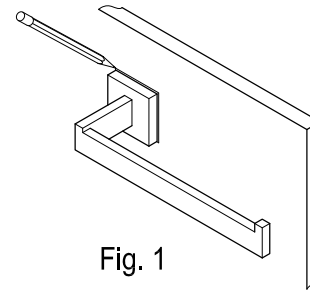

Fig. 1

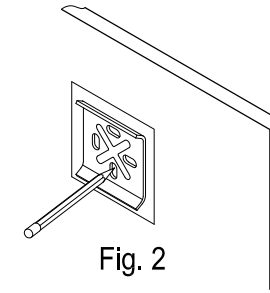

Fig. 2

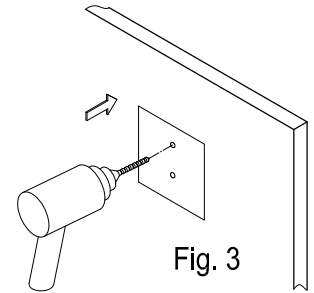

Fig. 3

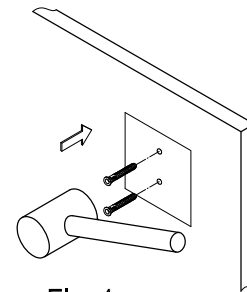

Fig. 4

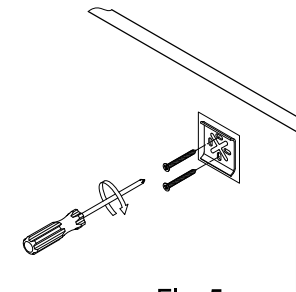

Fig. 5

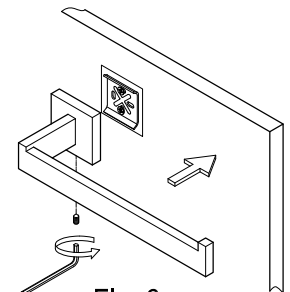

Fig. 6

### Installation Steps:

- Step 1. Locate where you would like to install the towel holder then measure the desired height on the wall where the towel holder will hang.
- Step 2. Place a base onto the wall and trace around it with a pencil (fig 1).
- Step 3. Place the mounting bracket (with the holes on a level) in the center of the pencil outline you just made and mark the location of the mounting screws (fig 2).
- Step 4. Remove the mounting bracket from wall and use a 1/4" drill bit to pre-drill holes in the drywall where pencil marks are drawn (fig 3).
- Step 5. Hammer in the drywall anchors until flush with the wall (fig 4).
- Step 6. Secure the mounting brackets (with the holes on a level) to the wall using the provided screws (fig 5).
- Step 7. Insert the unit with holes facing down to the bracket and tighten setscrews with an Allen wrench until the base is tight and secure (fig 6).

### Cleaning

Clean with a damp cloth only.  
Avoid using metal or abrasive polishes.



# KINGSTON

KITCHEN & BATH

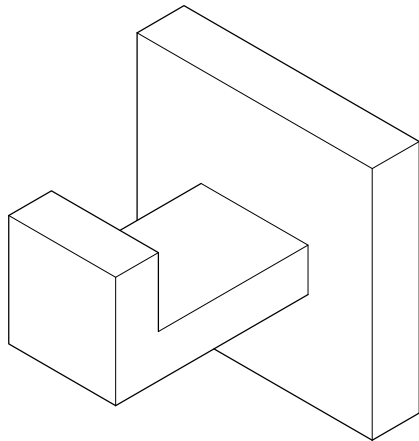
## Robe Hook Installation

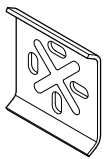
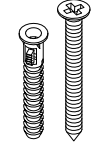

### Parts:

Mounting Bracket	Mounting Screw & Anchor	Set Screw
		
1 Pc	2 Pcs	1 Pc

## CAUTION

Failure to follow all installation directions may cause product to detach from the wall and cause serious injury

www.kingstonbrass.com  
TOLL-FREE CUSTOMER SERVICE: 1-877-2-KBRASS  
TECHNICAL SUPPORT E-mail: service@kingstonbrass.com  
12775 Reservoir Street, Chino, CA 91710

### TOOLS REQUIRED

 Allen Wrench

 Phillips Screwdriver

 Marking Pencil

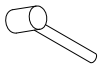
 Hammer

 Power Drill

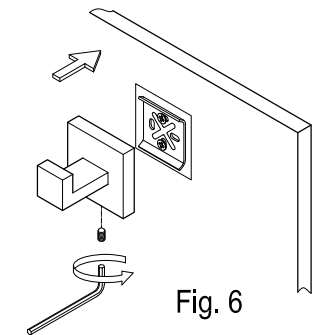
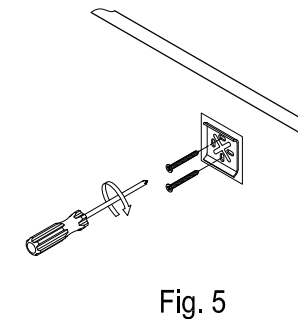
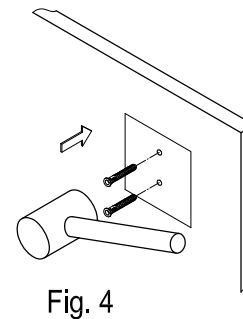
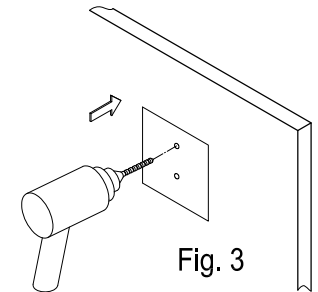
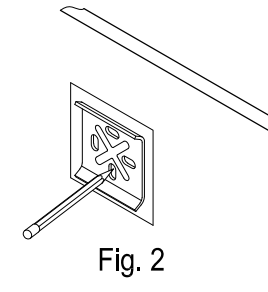
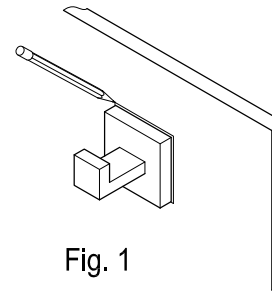

### Installation Steps:

- Step 1. Locate where you would like to install the robe hook then measure the desired height on the wall where the robe hook will hang.
- Step 2. Place a base onto the wall and trace around it with a pencil (fig 1).
- Step 3. Place the mounting bracket (with the holes on a level) in the center of the pencil outline you just made and mark the location of the mounting screws (fig 2).
- Step 4. Remove the mounting bracket from wall and use a 1/4" drill bit to pre-drill holes in the drywall where pencil marks are drawn (fig 3).
- Step 5. Hammer in the drywall anchors until flush with the wall (fig 4).
- Step 6. Secure the mounting brackets (with the holes on a level) to the wall using the provided screws (fig 5).
- Step 7. Insert the unit with holes facing down to the bracket and tighten setscrews with an Allen wrench until the base is tight and secure (fig 6).

### Cleaning

Clean with a damp cloth only.  
Avoid using metal or abrasive polishes.



# KINGSTON

KITCHEN & BATH

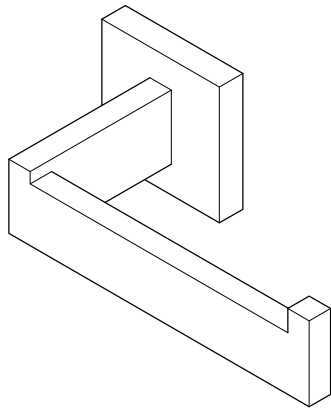
## Toilet Paper Holder Installation

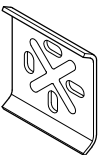
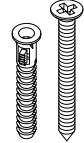

### Parts:

Mounting Bracket	Mounting Screw & Anchor	Set Screw
		
1 Pc	2 Pcs	1 Pc

## CAUTION

Failure to follow all installation directions may cause product to detach from the wall and cause serious injury

www.kingstonbrass.com  
TOLL-FREE CUSTOMER SERVICE: 1-877-2-KBRASS  
TECHNICAL SUPPORT E-mail: service@kingstonbrass.com  
12775 Reservoir Street, Chino, CA 91710

### TOOLS REQUIRED

 Allen Wrench

 Phillips Screwdriver

 Marking Pencil

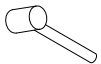
 Hammer

 Power Drill

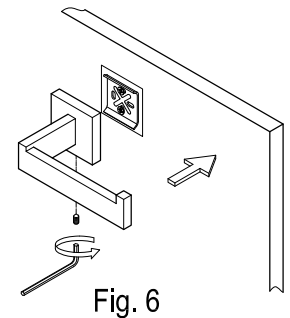
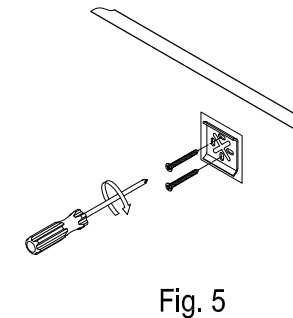
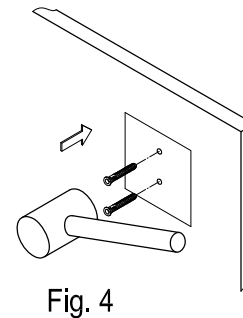
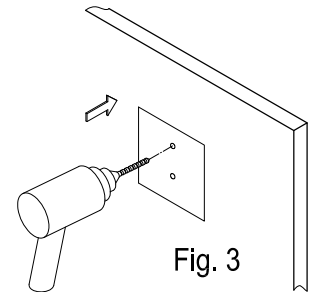
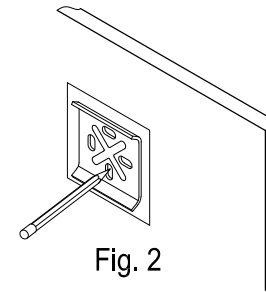
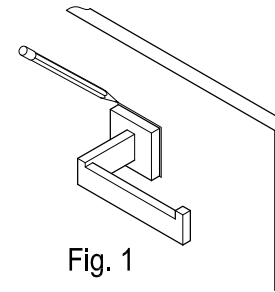

### Installation Steps:

- Step 1. Locate where you would like to install the toilet paper holder then measure the desired height on the wall where the toilet paper holder will hang.
- Step 2. Place a base onto the wall and trace around it with a pencil (fig 1).
- Step 3. Place the mounting bracket (with the holes on a level) in the center of the pencil outline you just made and mark the location of the mounting screws (fig 2).
- Step 4. Remove the mounting bracket from wall and use a 1/4" drill bit to pre-drill holes in the drywall where pencil marks are drawn (fig 3).
- Step 5. Hammer in the drywall anchors until flush with the wall (fig 4).
- Step 6. Secure the mounting brackets (with the holes on a level) to the wall using the provided screws (fig 5).
- Step 7. Insert the unit with holes facing down to the bracket and tighten setscrews with an Allen wrench until the base is tight and secure (fig 6).

### Cleaning

Clean with a damp cloth only.  
Avoid using metal or abrasive polishes.