

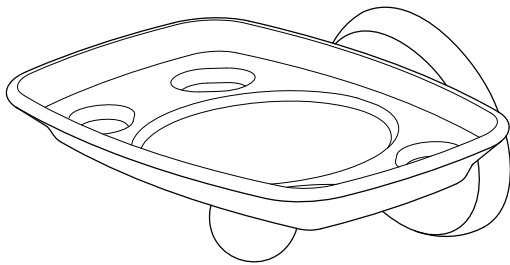

# KINGSTON

KITCHEN & BATH

## Toothbrush & Tumbler Holder Installation

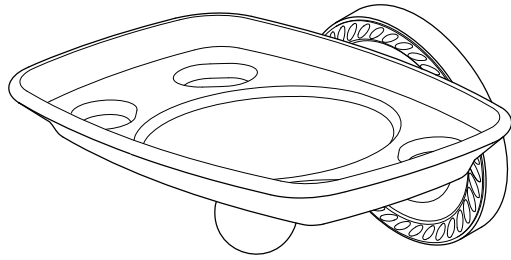

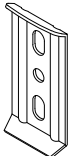
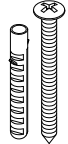
### Parts:

Mounting Plate	Mounting Screw & Anchor	Slotted Set Screw
		
1 Pc	2 Pcs	1 Pc

## CAUTION

Failure to follow all installation directions may cause product to detach from the wall and cause serious injury

www.kingstonbrass.com  
TOLL-FREE CUSTOMER SERVICE: 1-877-2-KBRASS  
TECHNICAL SUPPORT E-mail: service@kingstonbrass.com  
12775 Reservoir Street, Chino, CA 91710

### TOOLS REQUIRED

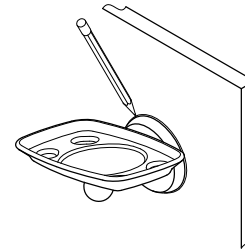
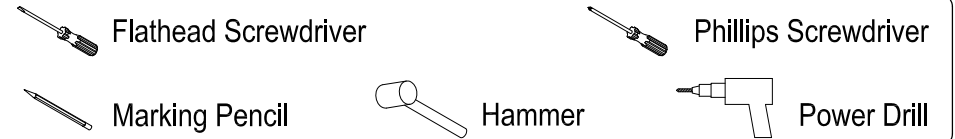

Fig. 1

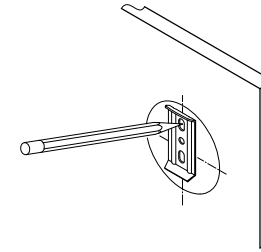

Fig. 2

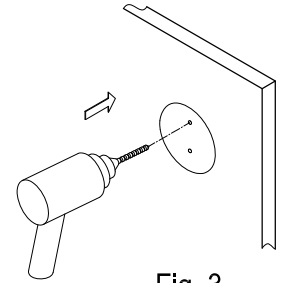

Fig. 3

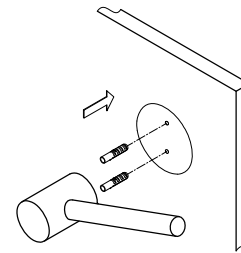

Fig. 4

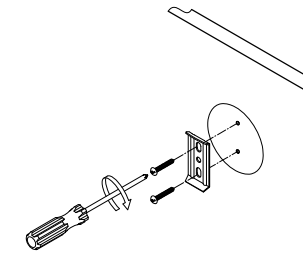

Fig. 5

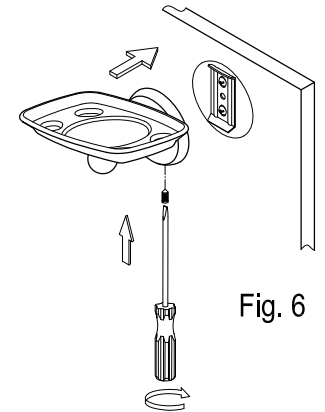

Fig. 6

### Installation Steps:

- Step 1. Locate where you would like to install the ceramic toothbrush & tumbler holder. Place a base onto the wall and trace around it with a pencil (fig 1).
- Step 2. Place the mounting plate in the center of the pencil outline you just made and mark the location of the mounting screws (fig 2). Drill holes at the marked locations (fig 3).
- Step 3. Insert anchors into the holes with a hammer until flush with the wall (fig 4).
- Step 4. Screw the mounting plate (with the lips facing out) to the wall with the mounting screws (fig 5). Ensure the curved end of the mounting plate is on top and the flat end at bottom before screwing on.
- Step 5. Place the unit, with the small hole in the base underneath, over the mounting plate by tightening the slotted set screw with a flat head screwdriver until the base is tightly fixed (fig 6).

### Cleaning

Clean with a damp cloth only.  
Avoid using metal or abrasive polishes.